

Nozzles and blowing accessories

The right injection tool for every application



Nozzles and blowing accessories

- ▶ Injection nozzles and rotary nozzles
- ▶ Injection needles and lances
- ▶ Insertion, sealing and venting accessories
- ▶ Hole saws and sealing parts



X-Floc Injection nozzles

Injection nozzles with pipe adapter (and ball valve)

Injection nozzles are particularly suitable for blowing fibre and core insulation materials (e.g. cellulose, EPS granulate) into double-shell masonry as well as for blowing in and re-compacting the insulation in joints, reveals and other small, hard-to-reach cavities. Injection nozzles are an indispensable tool in core insulation and a good choice for stud wall constructions and renovations. With these nozzles, the material flow in the cavity can be optimally directed and a large filling radius can be achieved. The throughput of insulation material is depending on the pipe size.

The injection nozzles require only small blow-in openings, which are not conspicuous or easy to conceal due to their small diameter. In exposed formwork for example, the boreholes can be closed again after backfilling with small cross-bar imber pieces. Thanks to their interchangeable inserts, the injection nozzles are also suitable for applications where abrasive insulation materials are used. The nozzle tube can be easily replaced by means of a wing nut lock, and longer tubes can be used for large insertion depths.

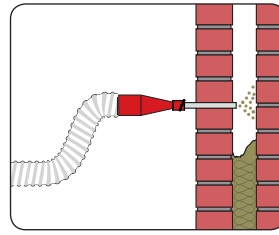

► Cavity wall insulation

Injection nozzles are often used for cavity walls made of brickwork.

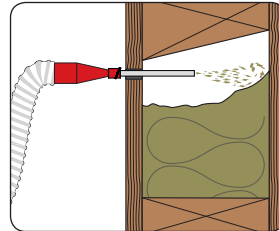

► Stud walls/renovation

Small and difficult-to-access cavities are another main area of application for injection nozzles.



Injection nozzle	ED38>18	ED38>18	ED50>14	ED50>14	ED50>16	ED50>18	ED50>18	ED50>18	ED50>18	ED50>21	ED50>21
Art.no.	5710	6377	11388	11460	11840	11387	11109	11803	11804	4959	5998
Nozzle outlet	straight	45°	straight	straight	straight	straight	straight	45°	45°	straight	straight
Shut-off ball valve	●	●	○	●	●	○	●	○	●	○	●
45° Outlet wear-resistant	○	●	○	○	○	○	○	●	●	○	○
Pipe ø (mm)	18	18	14	14	16	18	18	18	18	21	21
Total length L ₁ (mm)	430	430	320	400	400	320	385	430	510	310	385
Insert. depth L ₂ (mm)*	220	220	130	130	130	130	130	250	250	130	130
Hose connection	NW38 (1½")	NW38 (1½")	NW50 (2")	NW50 (2")	NW50 (2")	NW50 (2")	NW50 (2")	NW50 (2")	NW50 (2")	NW50 (2")	NW50 (2")
Spacer	optional	optional	optional	optional	○	optional	optional	optional	optional	optional	optional
Drill hole ø (mm)	>18	>18	>14	>14	>16	>18	>18	>18	>18	>21	>21
Weight (kg)	0,5	0,5	0,4	0,6	0,8	0,4	0,9	0,6	0,9	0,4	0,4

All values approximate. ● suitable/yes ○ no details/no *Indicated insertion depth = standard, other pipe lengths possible on request

X-Floc Injection nozzles

Dimensioning principle injection nozzles with pipe adapter and ball valve

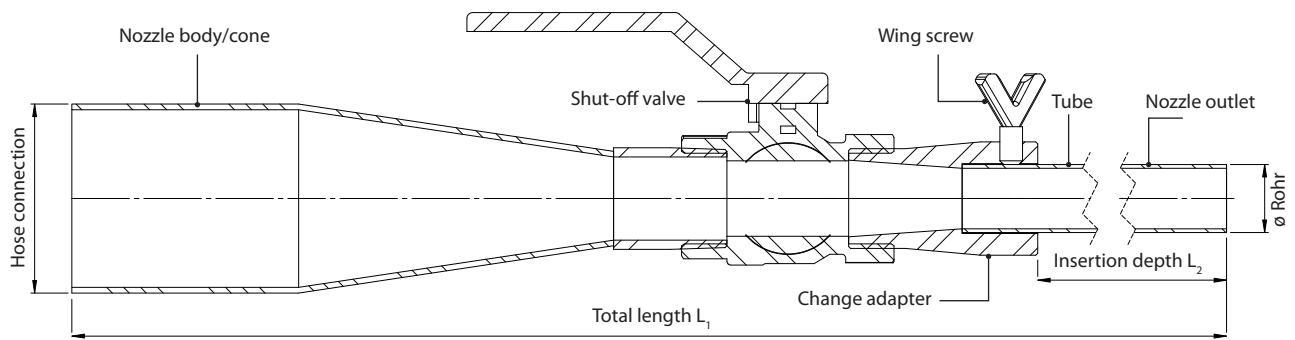

Characteristics of the different nozzle outlets

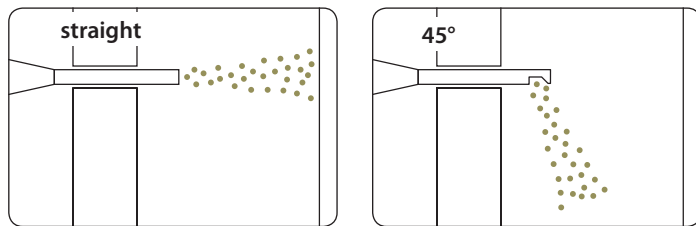

Accessories (optional)

Accessories	Diameter	Art.no.
Spacer	ø 14mm	11786
Ring for marking/limitation of the insertion depth, Material PE	ø 18mm	5945
	ø 21mm	6504
	ø 24mm	2333
	ø 29mm	2334

Other accessories can be found under „Blowing accessories“.



ED50>21	ED50>21	ED50>24	ED50>24	ED50>24	ED50>24	ED50>29	ED50>29	ED50>29	ED50>29	ED50>50	ED63>63	ED50>oval
6017	6201	11244	11435	11805	6415	11389	11456	11806	11457	6889	5670	1737
45°	45°	straight	straight	45°	45°	straight	straight	45°	45°	45°	90°	oval
○	●	○	●	○	●	○	●	○	●	○	○	○
●	●	○	○	●	●	○	○	●	●	●	○	○
21	21	24	24	24	24	29	29	29	29	50	63	50>75x14
430	510	300	385	430	510	285	385	430	510	250	300	250
250	250	130	130	250	250	130	130	250	250	○	○	○
NW50 (2")	NW50 (2")	NW50 (2")	NW50 (2")	NW50 (2")	NW50 (2")	NW50 (2")	NW50 (2")	NW50 (2")	NW50 (2")	NW50 (2")	NW63 (2½")	NW50 (2")
optional	optional	optional	optional	optional	optional	optional	optional	optional	optional	○	○	○
>21	>21	>24	>24	>24	>24	>29	>29	>29	>29	>50	>63	>77x15
0,6	0,9	0,4	0,8	0,6	0,8	0,4	0,6	0,6	0,9	0,8	0,6	0,4

X-Floc Rotary nozzles

Rotary nozzles: Injection nozzles with pivot bearing

The nozzle pipe of these injection nozzles is equipped with a pivot bearing (sliding bearing). With the help of the turning handle, the nozzle outlet can be turned comfortably.

This function is absolutely necessary for large, high cavities, because it allows the material flow to be directed in a targeted manner. In this way, a homogeneous compaction is achieved that complies with the approval.

In terms of the field of application, rotary nozzles are more or less the same as injection nozzles. However, in order to blow in elements with a large height or width professionally, a rotary nozzle is required. All X-Floc rotary nozzles have a nozzle outlet with shaping.

In combination with the rotating mechanism, the advantages of the steerable material flow are achieved. When working with rotary nozzles, it is important to note that the planking thickness is smaller than the insertion depth.

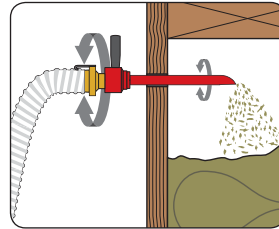
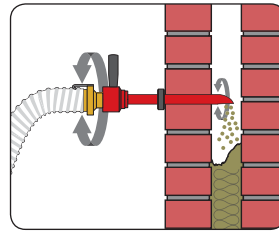

► Cavity wall insulation

Rotary nozzles are often used in cavity wall insulation, where insulation material is inserted through a narrow opening in a two-shelled masonry wall.

► Stud walls/restoration

Cavities that are difficult to access with great height or width are another main area of application for rotary nozzles.



Rotary nozzle	DD50>24	DD50>24-45°	DD50>24-90°	DD50>29	DD50>29-90°	DD50>35	DD50>35-45°	DD63>35	DD63>35	DD50>29-45°
Article number	852	6291	2828	544	4788	3569	6297	2496	8503	8081
Nozzle outlet	shaped	45°	angled*	shaped	angled*	angled*	45°	angled*	shaped	45°
Insulation strength S_D (cm)	>4	>4	>4	>4	>4	>4,5	>4,5	>4,5	>4,5	>4
Suitability insulation materials:										
Cellulose	●	●	●	●	●	●	●	●	●	●
Wood fibre	○	○	○	○	○	○	○	○	○	○
Glass and rock wool	○	●	○	○	○	○	●	○	○	●
Bulk materials	●	●	●	●	●	●	●	●	●	●
Pipe diameter (mm)	24	24	24	29	29	35	35	35	35	29
Total length L_1 (mm)	420	420	380	350	445	337	337	337	337	420
Insertion depth L_2 (mm)	277	277	235	209	300	195	195	195	195	270
Hose connection	NW50 (2")	NW50 (2")	NW50 (2")	NW50 (2")	NW50 (2")	NW50 (2")	NW50 (2")	NW63 (2½")	NW63 (2½")	NW50 (2")
Hose fastener	●	●	●	●	●	●	●	●	●	●
Spacer	●	●	●	●	●	●	●	●	●	●
Drill hole required (mm)	>26	>26	>26	>30	>31	>37	>37	>37	>37	>31
Material	steel/alu	steel/alu	steel/alu	steel/alu	steel/alu	steel/alu	steel/alu	steel/alu	steel/alu	steel/alu
Surface	powder-coated/ anodised	powder-coated/ anodised	powder-coated/ anodised	powder-coated/ anodised	powder-coated/ anodised	powder-coated/ anodised	powder-coated/ anodised	powder-coated/ anodised	powder-coated/ anodised	powder-coated/ anodised
Weight (kg)	1,0	1,0	1,0	1,0	1,0	1,1	1,1	1,1	1,1	1,0

All values approximate. ● well-suited/yes ○ recommended with limitation ○ unsuitable/no/no details

X-Floc Rotary nozzles

Dimensioning principle rotary nozzles

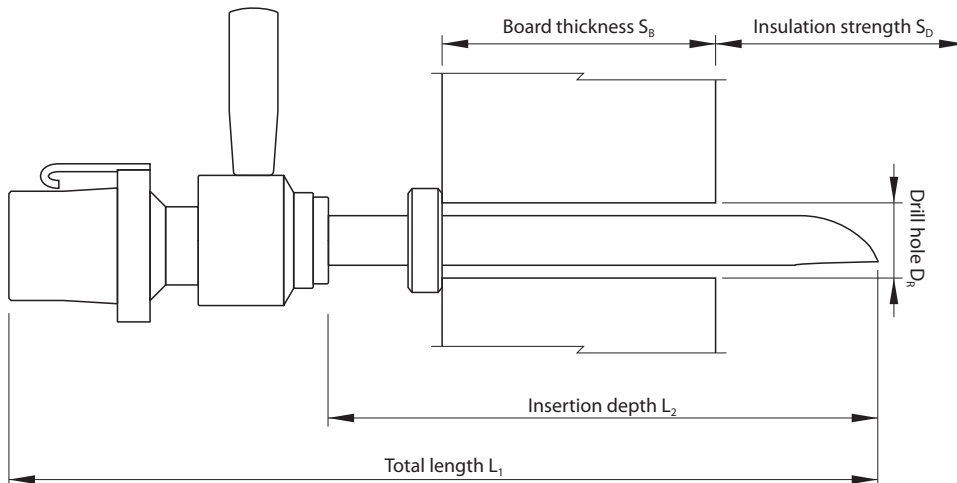

DD63>35-45°	DD75>50	DD75>50-45°
7146	2997	8128
45°	angled*	45°
>4,5	>5	>5
● ○ ● ●	● ○ ● ●	● ● ● ●
35	50	50
333	360	370
195	213	230
NW63 (2½")	NW75 (3")	NW75 (3")
● ●	● ●	● ●
>37	>52	>52
steel/alu	steel/alu	steel/alu
powder-coated/ anodised	powder-coated/ anodised	powder-coated/ anodised
1,1	1,1	1,1

Injection nozzles:

General information

- ▶ Nozzle outlet angled*: 90°
Pipe bend and straight sawn off ensures good deflection of the material flow with good insertion into the drill hole.
- ▶ The larger the nozzle, the higher the flow rate
- ▶ With small nozzle cross-sections (<30mm), the flow of material must be reduced by means of a sluice gate on the machine.
- ▶ For materials with a high specific weight (<80kg/m³) hoses with smaller cross-sections are preferable to increase the air speed.
- ▶ The cranked or angled nozzle outlet can be used for abrasive fluids can wear out wear out in a short time.



Cavity wall insulation



Manhole filling

X-Floc Rotary nozzles

Ventilated rotary nozzles

With dry injection, loose insulation material is inserted through a into fully closed cavities (stud wall constructions) through a injection hole. The filling takes place by means of a vented rotary nozzle from the bottom upwards, whereby air transports and distributes the insulation material. An overpressure is created in the cavity during the blowing process, which compresses the insulation material as the filling level increases. Excess air is removed in a controlled manner. With the help of the vented rotary nozzle, the excess air is guided through the perforated plate cage into the dust bag, filtered and discharged from the component. This reduces the amount of dust generated during injection to a minimum. Blowing in with a ventilated rotary nozzle also saves time and effort.



Dry injection with a ventilated rotary nozzle

Passive venting

The excess air is discharged automatically by the overpressure..

Active venting

The excess air is actively removed in a controlled manner by a suction device at the outlet nozzle of the rotary nozzle.



Rotary nozzle	X-Jet 63	X-Jet 63 with clamping ring	X-Jet 75	X-Jet 75 with clamping ring	J-Jet 75	J-Jet 75>75	S-Jet 63 ¹⁾
Article number	1708	3843	1789	2929	3795	8477	4910
Nozzle outlet	angled*	angled*	angled*	angled*	angled*	angled*	shaped
Passive/active venting	●	●	●	●	●	●	●
∅ Nozzle pipe/hose (mm)	35	35	50	50	50	60	NW63
Suitability insulation materials:							
Cellulose	●	●	●	●	●	●	●
Wood fibre	○	○	●	●	●	●	●
Glass and rock wool	○	○	●	●	●	●	●
Bulk materials	○	○	○	○	○	○	○
Insulation strength min. S_0 (cm)	>5,5 ²⁾	>7,5	>8,5 ²⁾	>10	>14	>14	>16
Insulation strength max. S_0 (cm)	<30	<20	<40	<40	<45	<60	<60
Board thickness S_B (mm)	<40	15...35	<40	15...35	10...75	10...75	10...75
Flange adjustable	○	○	○	○	●	●	●
Total length L_1 (mm)	333	333	371	371	426	465	390
Insertion depth L_2 (mm)	L_3-S_B	L_3-S_B	L_3-S_B	L_3-S_B	140	160	160
Length L_3 (mm)	98	82	126	110	○	○	○
Hose connection D_5	NW63 (2½")	NW63 (2½")	NW75 (3")	NW75 (3")	NW75 (3")	NW75 (3")	NW63 (2½")
Hose fastener	●	●	●	●	●	●	○
Drill hole D_R (mm)	85...87	106,5	106,5...107,5	106,5	105...115	105...115	105...115
Pivot bearing	sliding ring and ball bearing				sliding ring		
Material	steel/stainless steel/alu/plastic				alu/stainless steel		

All values approximate. ● well-suited/yes ○ recommended with limitation ○ unsuitable/no/no details

X-Floc Rotary nozzles

Filling concept

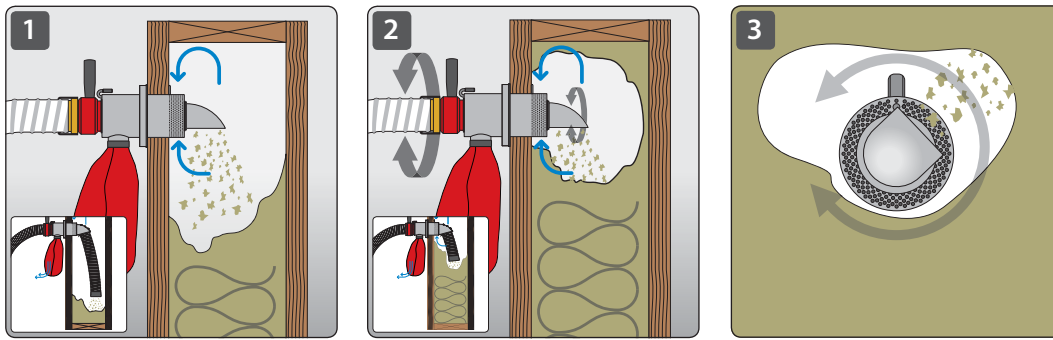

The ventilated rotary nozzle is placed in custom-fit injection hole which is made with a hole saw. The element is filled (1) up to the height of the nozzle outlet. The pressure sound change from a noisy to a airless, quiet pressure sound (2). Now the nozzle outlet must be turned one after another to both element corners thus achieving an ideal insulation density in the upper area (3).

X-Jet: Vented rotary nozzle with clamping springs or clamping ring

Advantages at a glance

- ▶ Reduces the risk of deformation by ventilation
- ▶ Fixation in the drill hole with clamping springs (alternatively with clamping ring)
- ▶ Rotary bearing with sliding ring and ball bearing
- ▶ Available in two sizes NW63 (2½") or NW75 (3"), in each case also available with clamping ring
- ▶ Product variants:
X-Jet 63 art.no. 1708 / with clamping ring art.no. 3843
X-Jet 75 art.no. 1789 / with clamping ring art.no. 2929
- ▶ Clamping ring, suitable for X-Jet 63 / X-Jet 75 retrofittable
- ▶ Technical data: see table on page 6

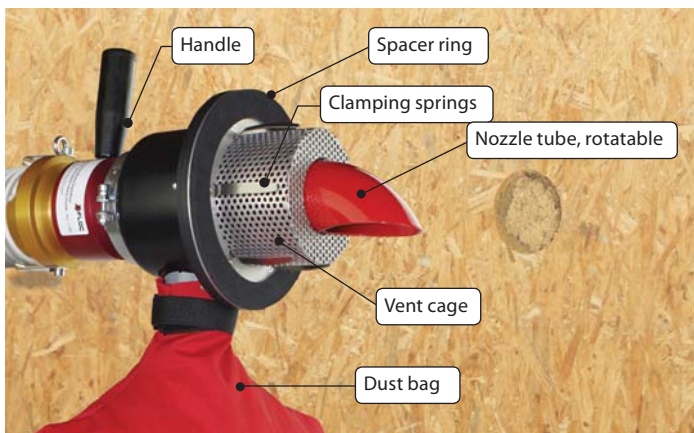

X-Jet with clamping springs



X-Jet with clamping ring

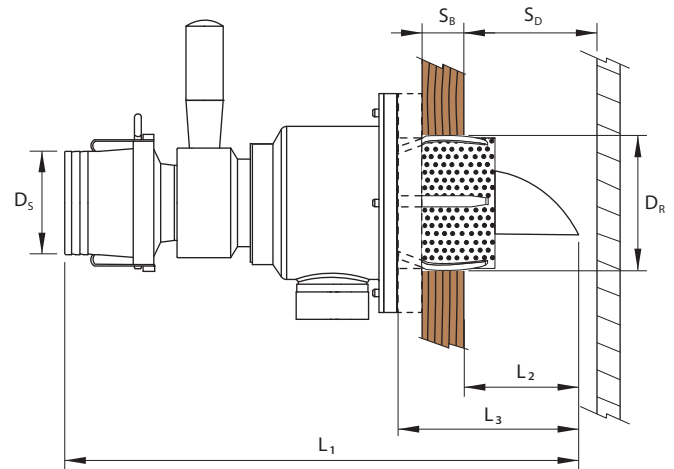

Accessories	Description	Art. no.
Clamping ring	ø 106,5mm	2223
Spacer ring	10mm	4372
	15mm	4374
	25mm	4373
Hole saw with ejection	ø 106,5mm	4966
Hole saw professional	ø 106,5mm	1733
Hole saw HF with ejection	ø 106,5mm	9145
Sealing corks	ø 106mm	1948
Sealing plugs	ø 106mm	4673

Hole saws ø 85mm as well as sealing corks/plugs ø 85mm and other accessories can be found under the heading „Blowing accessories“.

X-Floc Rotary nozzles

J-Jet: Vented rotary nozzle with adjustable clamping flange

Advantages at a glance

- ▶ Reduces the risk of deformation by ventilation
 - ▶ Economical by saving of time
 - ▶ Effort-saving operation
 - ▶ Dust-free process
 - ▶ Simple fixing by sash lock
 - ▶ Adjustable clamping flange for different board thicknesses
- ▶ Product variants:
J-Jet 75 art.no. 3795
J-Jet 75>75 art.no. 8477
 - ▶ Technical data: see table on page 6



J-Jet with adjustable clamping flange

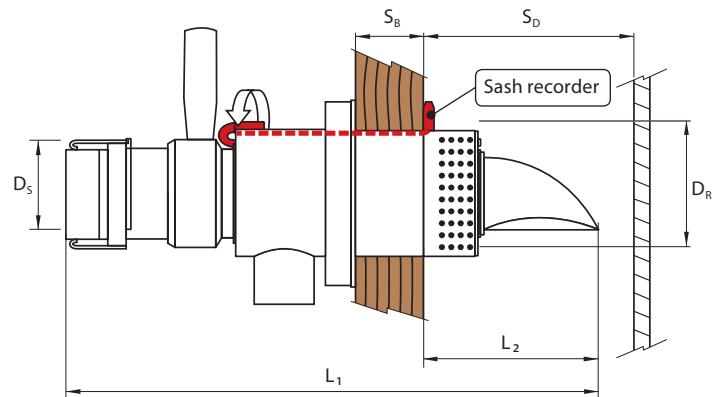

Filling concept

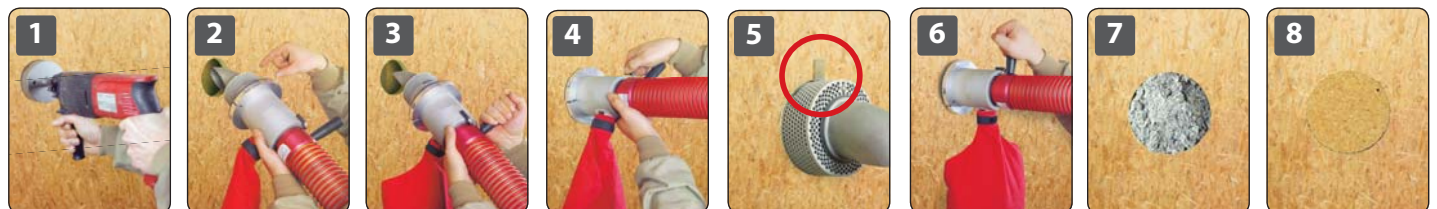

Make the injection opening with the help of a hole saw (1) Adjust the clamping flange (2) Insert the rotary nozzle into the injection opening (3) Clamp the nozzle (4) and fix it by means of a sash recorder (5) Inject the insulation material (6) Fill up the tool displacement manually (7) Close the injection opening with a sealing cork (8)



Vented rotary nozzle X-Floc J-Jet: Optimised for high throughputs

Accessories	Description	Art.no.
Hole saw with ejection	∅ 106,5mm	4966
Hole saw professional	∅ 106,5mm	1733
Hole saw HF with ejection	∅ 106,5mm	9145
Sealing corks	∅ 106mm	1948
Sealing plugs	∅ 106mm	4673

Other accessories can be found under the heading „Blowing accessories“.

X-Floc Rotary nozzles

S-Jet: Vented rotary nozzle with integrated hose feed-through

The S-Jet is a logical step in the development of rotary nozzle technology. The fusion of the processes makes it possible to fill deep long cavities and compress them evenly with only one injection tool. Thanks to the sealed hose feed-through, there is hardly any loss of insulation material during injection.

The excellent ventilation also ensures minimal dust development and low component stress during blowing.

A movable soft NW63 (2½") delivery or blow-in hose is included in the scope of delivery. However, the S-Jet can also be supplied with a stiffer blow-in hose on request.

Advantages at a glance

- ▶ Combines the advantages of hose and rotary nozzle blowing due to integrated hose feed-through
- ▶ Simple fixing by sash lock
- ▶ Adjustable to different planking thicknesses due to adjustable flange
- ▶ Suitable for walls, sloping roofs and ceilings
- ▶ S-Jet 63 art.no. 4910
- ▶ Technical data: see table on page 6

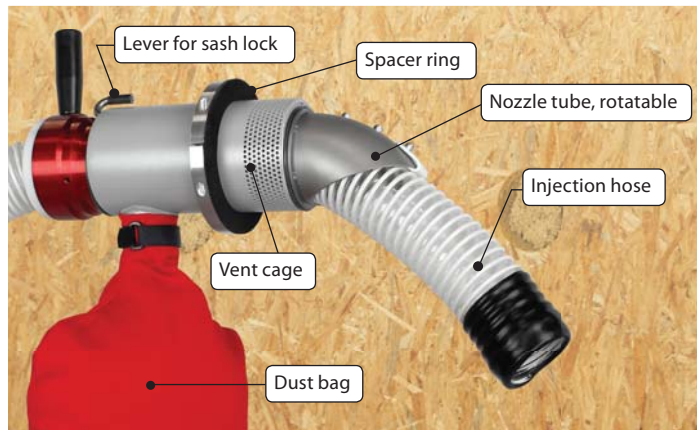

S-Jet with integrated hose feed-through

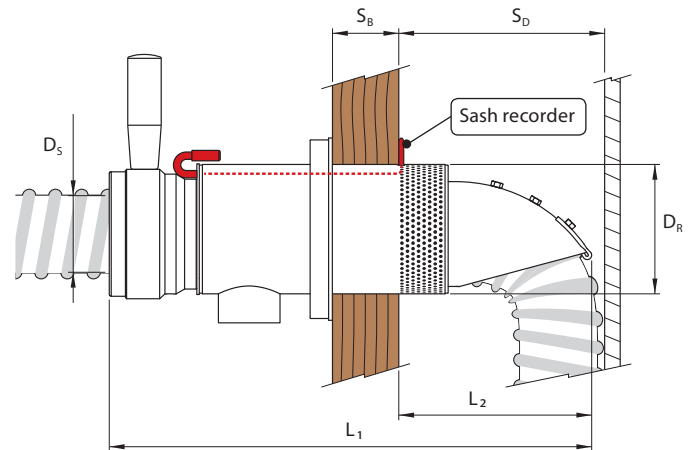

Filling concept

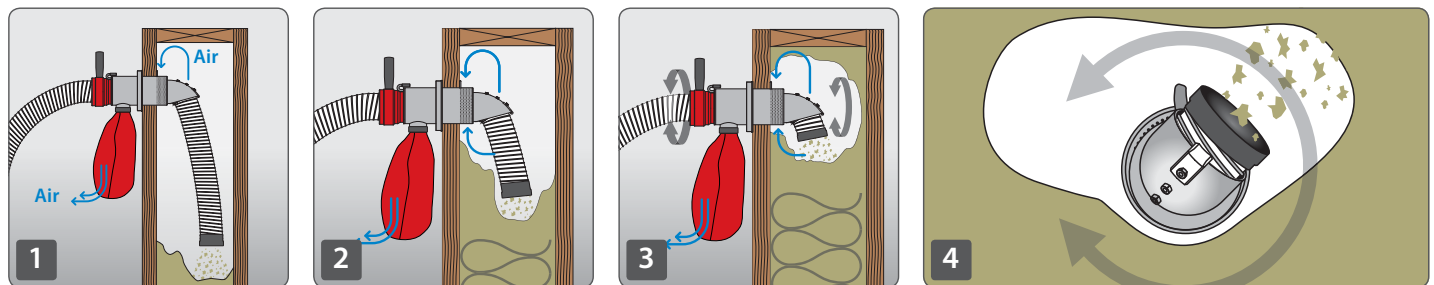

At the beginning of the injection process, guide the hose to the end of the compartment (1) Pull the hose back gradually during filling. The stop at the front end of the hose prevents it from slipping out (2) at the hose stop use like a rotary nozzle (3) Fill the compartment corners by turning the nozzle head (4)



Accessories	Description	Art.no.
Hole saw with ejection	ø 106,5mm	4966
Hole saw professional	ø 106,5mm	1733
Hole saw HF with ejection	ø 106,5mm	9145
Sealing corks	ø 106mm	1948
Sealing plugs	ø 106mm	4673

Other accessories can be found under the heading „Blowing accessories“.

Venting cage and connected dust bag guarantee excellent venting and minimal dust generation. The sash lock and the adjustable flange with gasket close the injection opening well and allow comfortable operation.

X-Floc Injection needles

Injection needles with piercing aid

Accurate filling and compacting: X-Floc injection needles are primarily bent aluminium tubes for precise insertion of insulation material, for re-compacting insulation layers and buffer insulation as well as for blowing in slots and hard-boarded compartments with a sufficiently large blow-in outlet. The specially shaped pipe tip facilitates the piercing of foils and boards.

For blowing in horizontal elements and e.g. for blowing in roof slopes (from the unfinished attic), the blowing needles are also available in a straight version.

Advantages at a glance

- ▶ Due to the good ergonomics, climbing steps are not necessary
- ▶ Low weight due to thin-walled aluminium tube
- ▶ Bending makes it easy to reach even distant corners
- ▶ Smooth surface for easy sealing and avoidance of insulation residues when pulling out the needle
- ▶ Specially shaped tube tip with coloured marking for easy shifting or for directing the flow of material.

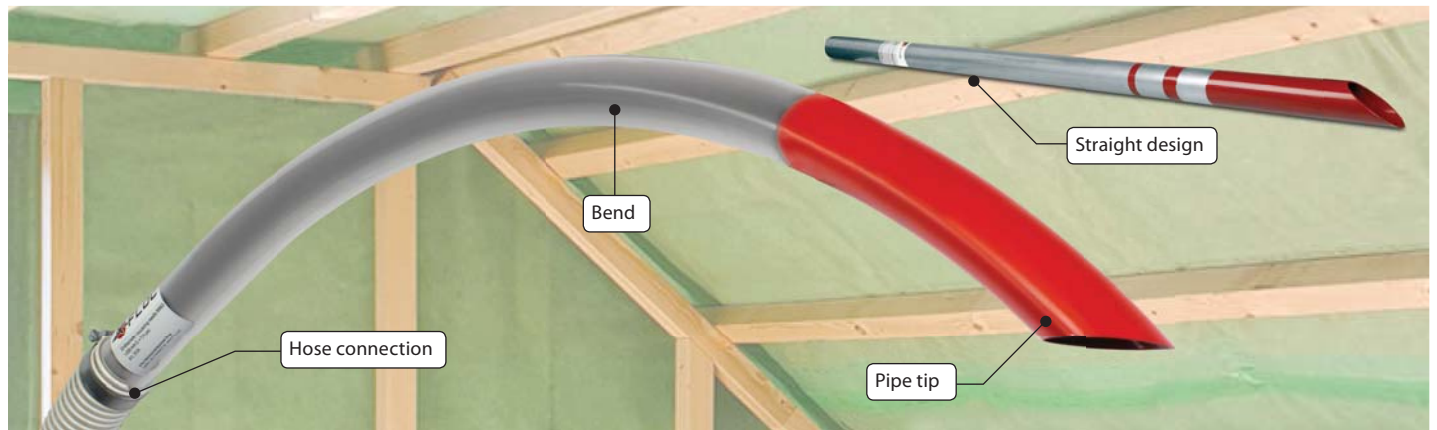

Filling concept

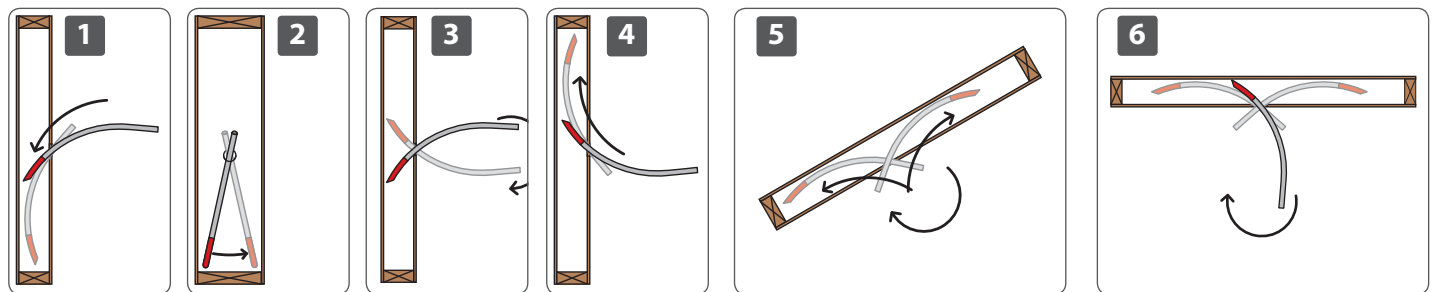

Example: stud wall

Insert injection needle (1), swivel (2), pull out and turn upwards (3) Fill upper area by swivelling (4)

Example: Sloping roof (5) and ceiling (6)

Start blowing in at the lower end of the rafter

Injection needle	Min. insulation strength S_D	Hose connection ϕ	Injection opening	Total length L	Art.no.
NW50-100	approx. 100mm	NW50 (2")	ϕ 120mm	approx. 100cm	6180
NW38-130	approx. 120mm	NW38 (1½")	ϕ 120mm	approx. 130cm	5304
NW50-140	approx. 170mm	NW50 (2")	ϕ 120mm	approx. 140cm	5303
NW63-140	approx. 230mm	NW63 (2½")	ϕ 120mm	approx. 140cm	5836
NW75-140	approx. 310mm	NW75 (3")	ϕ 120mm	approx. 140cm	6710
NW50-180	approx. 200mm	NW50 (2")	ϕ 120mm	approx. 180cm	5153
NW63-180	approx. 270mm	NW63 (2½")	ϕ 120mm	approx. 180cm	6390
NW75-180	approx. 340mm	NW75 (3")	ϕ 120mm	approx. 180cm	6711
NW38-straight	all insulation thicknesses	NW38 (1½")	ϕ >38mm	up to 600cm*	6028
NW50-straight		NW50 (2")	ϕ >50mm	Standard length: 300cm	5730
NW63-straight		NW63 (2½")	ϕ >63mm		5839
NW75-straight		NW75 (3")	ϕ >75mm	5840	

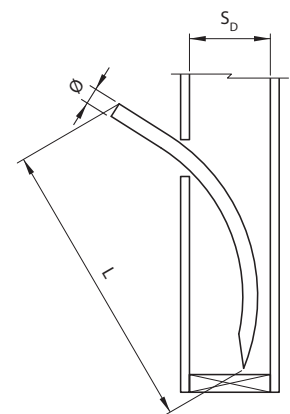

* Specify desired length when ordering.

X-Floc Injection needles

Comparison of injection needles

▶ Injection needle NW50-100
Art.no. 6180

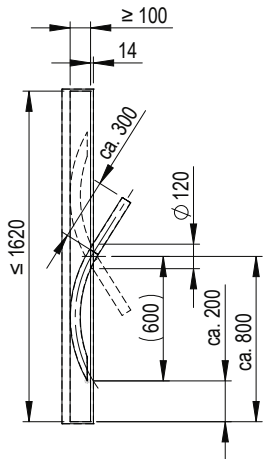

▶ Injection needle NW38-130
Art.no. 5340

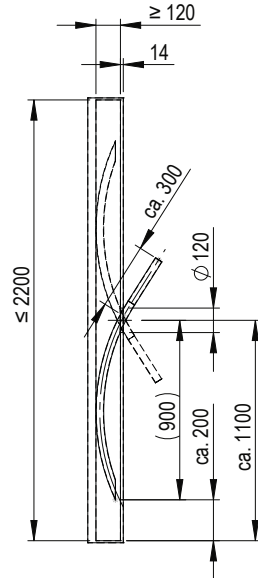

▶ Injection needle NW50-140
Art.no. 5303

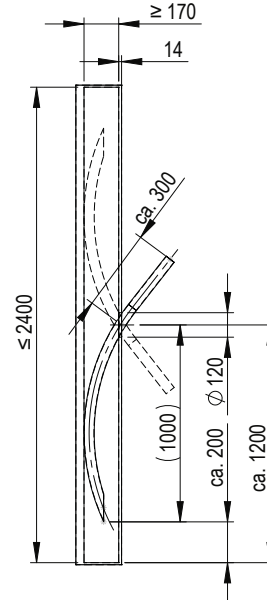

▶ Injection needle NW63-140
Art.no. 5836

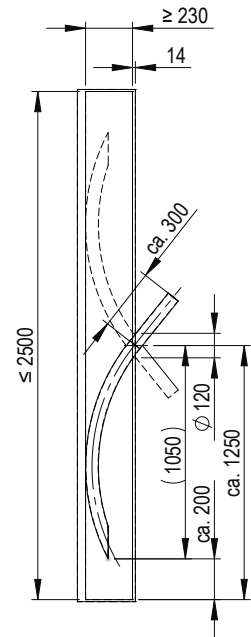

▶ Injection needle NW75-140
Art.no. 6710

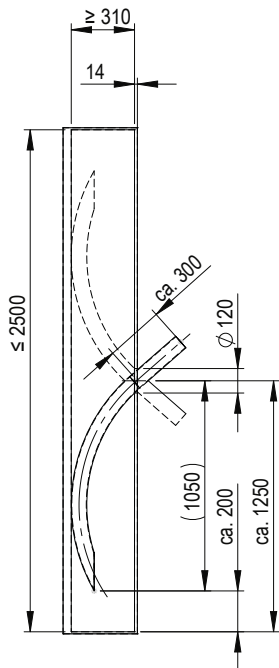

▶ Injection needle NW50-180
Art.no. 5153

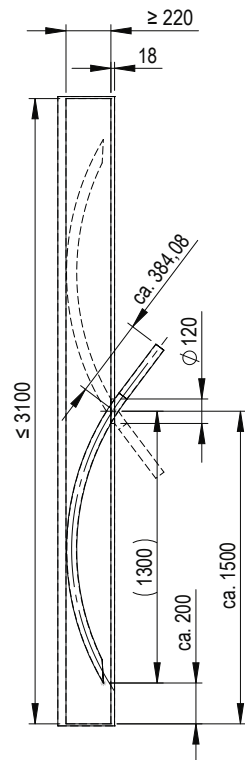

▶ Injection needle NW63-180
Art.no. 6390

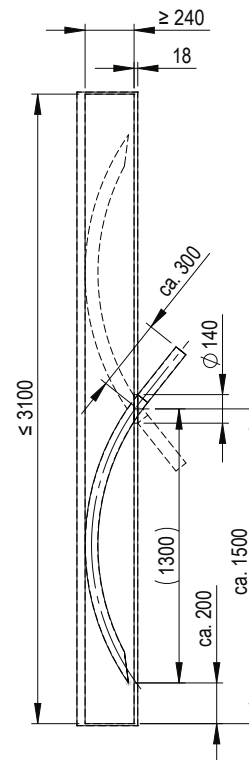

▶ Injection needle NW75-180
Art.no. 6711

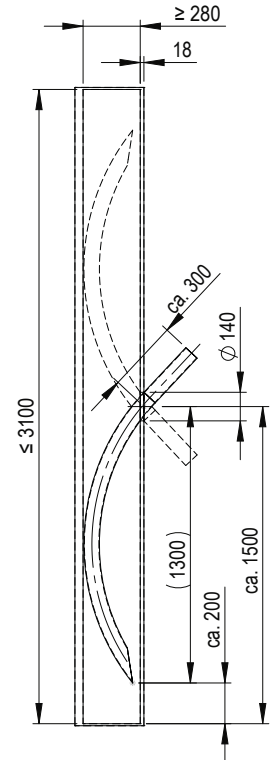

The specifications correspond to the minimum insulation strengths for fixed planking with 120 mm drill holes. With foils or long holes (e.g. two overlapping holes 106,5 mm = approx. 170 mm long hole), the needles can already be used with lower insulation thicknesses.

For optimal handling of the blow-in needles, we recommend the matching connection sets and hose swivel connectors as a supplement.

X-Floc Injection needles

Connection sets and accessories

The matching connection set is the optimal addition for easy handling of the injection needle. Each set contains a 4m long flexible conveying hose, a reducer tube connector, two hose clamps and a sealing sponge.

Also rotatable hose connectors (SDVxx) are available as an option, allowing easy handling of the injection and delivery hoses without creating loops. These connectors are compatible with our entire range of hoses and can be perfectly combined with the injection needle and connection set.

Connection recommendation and preparation

We recommend hose swivel connectors, as these allow easy and make it easier to work with the injection needle.

- ▶ Good manoeuvrability due to long upstream working hose
- ▶ Avoidance of hose blockages
- ▶ Highest possible throughput/performance

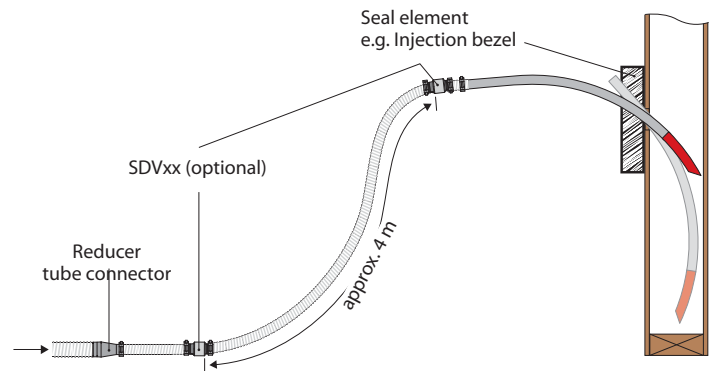

Rotary hose connectors (SDV) facilitate working with the injection needle

suitable for injection needle	Art.no.	6180	5304	5303	5836	6710	5153	6390	6711	6028	5730	5839	5840
Connection set NW75>50	6103	●	○	●	○	○	●	○	○	○	●	○	●
Connection set NW63>50	6206	●	○	●	○	○	●	○	○	○	●	○	○
Rotary hose connector SDV50	6522	●	○	●	○	○	●	○	○	○	○	○	○
Connection set NW63>38	6104	○	●	○	○	○	○	○	○	●	○	○	○
Connection set NW75>63	6124	○	○	○	●	○	○	●	○	○	○	●	●
Rotary hose connector SDV63	6896	○	○	○	●	○	○	●	○	○	○	○	○
Connection set NW90>75	10141	○	○	○	○	●	○	○	●	○	○	○	○
Rotary hose onnector SDV75	4451	○	○	○	○	●	○	○	●	○	○	○	○

● suitable/yes ○ unsuitable/no



Injection needles are also ideally suited for filling hard-boarded compartments

Recommended injection openings

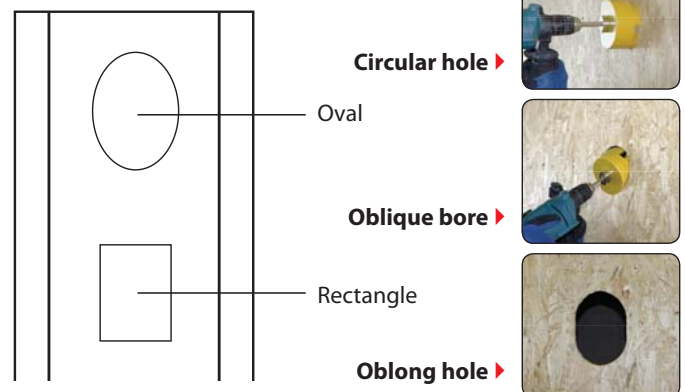

X-Floc Injection needles

Connection sets

The connection set is an obligatory accessory and indispensable for effective work with the injection needle. For suitable needle set combinations, please refer to the table on the previous page. Each connection set includes the following accessories as standard:

1x Transport hose

Transparent spiral hose made of PU/PVC compound for the material transport of non-abrasive insulation materials.

1x Reducer tube connector









Transition piece made of high-strength aluminium for connecting injection and transport hoses with different diameters. Maximum sealing effect, material clogging practically excluded..

2x Hose clamps

Screw clamps for securing hose connections. The wide steel band protects the hose and provides a firm hold.

1x Sealing sponge

Foam sponge made of special air-permeable material for sealing injection openings during injection.



Conveying hose		Art.no.
	NW38 (1½")	414
	NW50 (2")	329
	NW63 (2½")	573
	NW75 (3")	284
Reducer tube connector		Art.no.
	NW75>50 (3">2")	1262
	NW63>50 (2½">2")	1264
	NW63>38 (2½">1½")	1970
	NW75>63 (3">2½")	1261
	NW90>75 (3½">3")	1971
Hose clamps		Art.no.
	NW38 (1½")	518
	NW50 (2")	175
	NW63 (2½")	176
	NW75 (3")	177
Sealing sponge		Art.no.
	NW38/NW50	7101
	NW50/NW63	7100
	NW63/NW75	7099

Of course, the accessories are also available individually and the sets can be adapted to special customer requirements.

Hose connector rotatable

For easy turning and for easy handling of the hoses without looping, we recommend the use of rotatable hose connectors. The thin-walled, smooth aluminium connectors are smooth-running. The grooves on both sides ensure a firm hold of the hoses and a rubber seal provides an optimal seal.

The connectors can be completely dismantled for cleaning.

Rotary hose connector	for injection needle	Art.no.
	SDV50	Art.no. 6180, 5303, 5153 6522
	SDV63	Art.no. 5836, 6390 6896
	SDV75	Art.no. 6710, 6711 4451

Further accessories

Accessories	Description	Art.no.
Injection bezel universal	ø 30...60mm	8787
	ø 45...70mm	8906
	ø 65...100mm	8907
Hole saw	ø 106,5mm	4966
	ø 120mm	5282
Hole saw professional	ø 106,5mm	1733
Hole saw HF	ø 106,5mm	9145
Sealing corks	ø 106mm	1948
	ø 120mm	4671
Sealing plugs	ø 109mm	8950
	ø 120mm	8951

Further accessory details can be found under the heading „Blowing accessories“.



Injection needle with specially shaped, colour-marked tube tip as a piercing aid

X-Floc Injection lances

Vented injection lances

The injection lance is used to fill horizontal or only slightly inclined wall, roof and ceiling elements. The double pipe construction ensures good drainage of the excess air. The loose insulation material is blown into the cavity through the pointed sawn-off inner pipe, the conveying air is discharged from the cavity via the annular gap between the inner and outer pipe. This can be done via the venting cage and the dust bag supplied (passive venting) or via a suction station with suction drum (active venting).

The material-carrying inner pipe allows a high insulation throughput and can be earthed if required. The electrostatic charge that can arise from the transport of insulation material is thus effectively dissipated.

Advantages at a glance

- ▶ The lightweight design ensures ease of operation and therefore also saves time during the injection process
- ▶ Rigid design enables controlled blowing-in process as well as uniform distribution and compaction
- ▶ Low stress on the cladding materials due to ventilation
- ▶ Hardly any insulation material adheres thanks to the smooth outer wall
- ▶ Small outer diameter, so that e.g. the sill is not unnecessarily weakened
- ▶ Material outlet steerable thanks to pointed sawn-off inner pipe



Industrial-grade element filling with the aid of vented injection lances

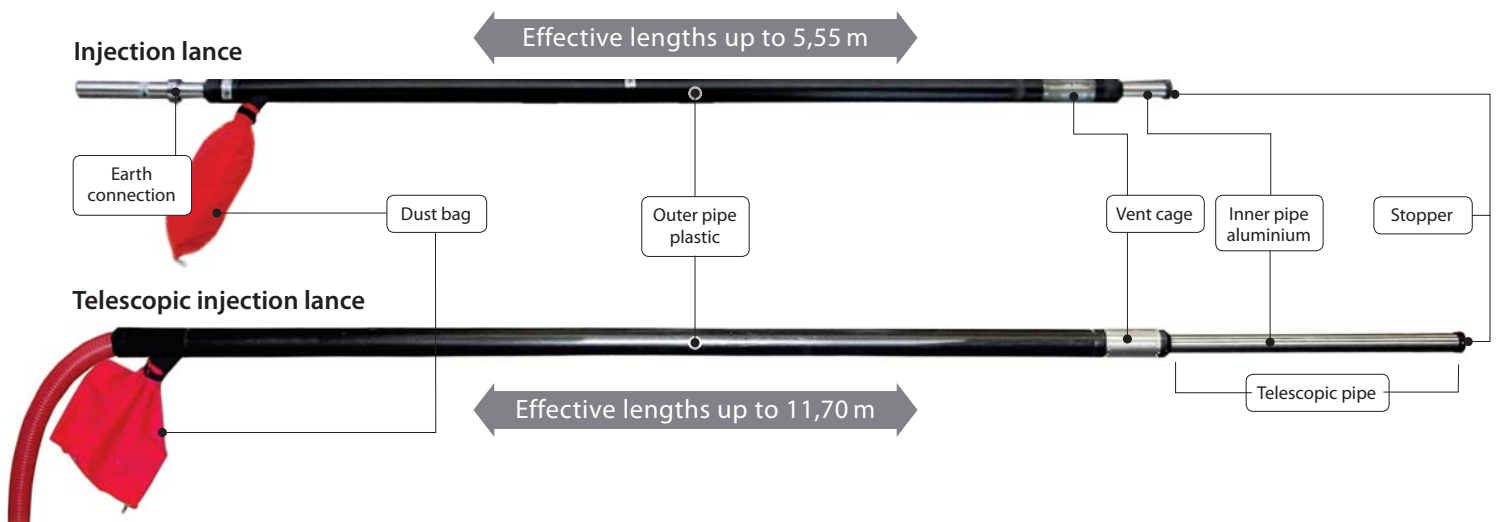

Freely selectable lance length

During the filling process, the lance is inserted through an injection opening in the frame of the element along its entire length. The rigid injection lance can be used up to a maximum effective length of 5,55m. For element lengths from 4,00m up to 11,70m the use of a telescopic injection lance is recommended. For good handling, the rear space must be sufficiently dimensioned or larger than the total length of the injection lance.



Injection lance nozzle with dust bag



Pointed sawn-off inner pipe

X-Floc Injection lances

Rigid injection lance

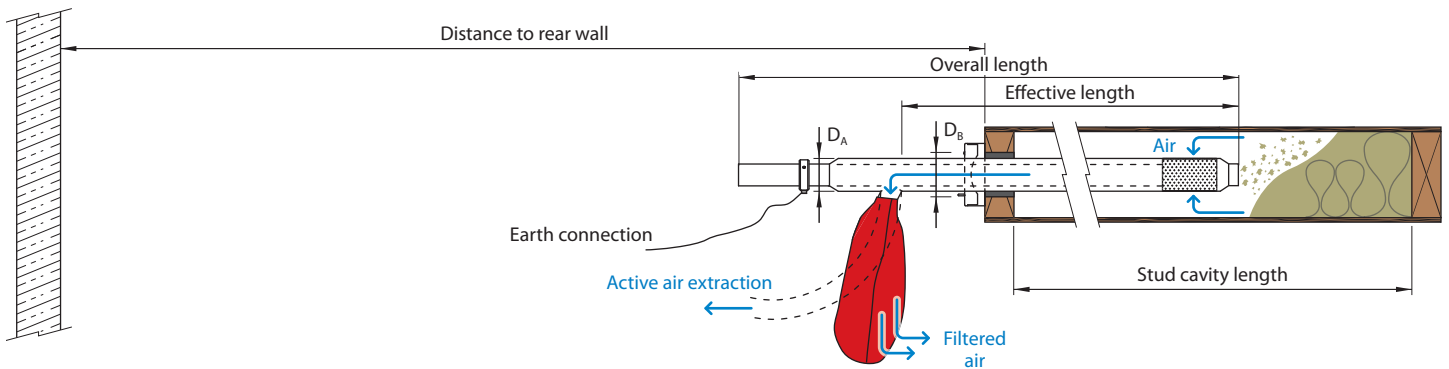

Determination of the lance length:

Effective length = stud cavity length + frame thickness + thickness of the injection sleeve (optional)

Overall length = effective length + 450 mm

Telescopic injection lance

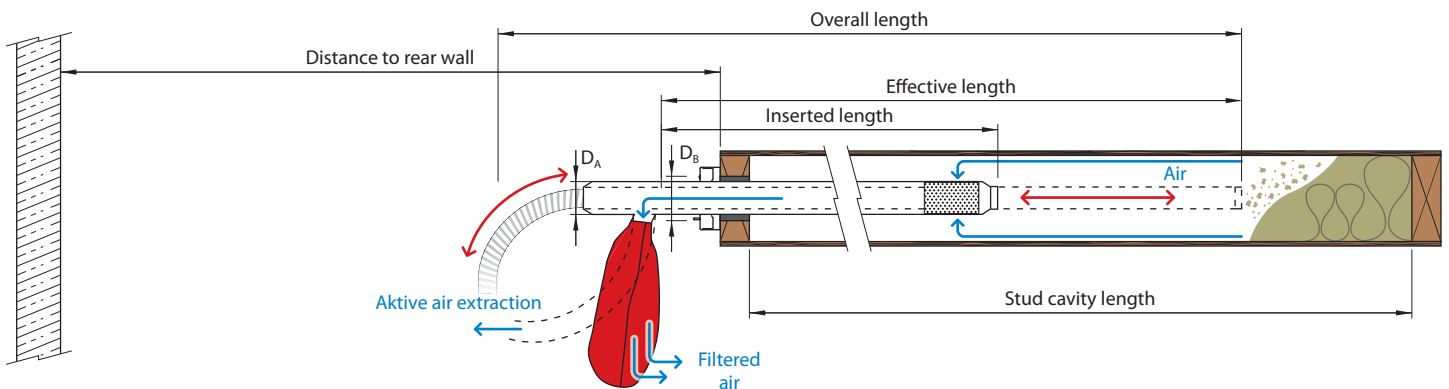

Determination of the lance length:

Effective length = stud cavity length + frame thickness + thickness of the injection sleeve (optional)

Overall length (lifted) = effective length + 450 mm

Overall length (inserted) = $\frac{\text{effective length}}{2} + 750 \text{ mm}$

Accessories (optional)

Injection lance	NW75/50	NW90/63	Teleskop NW 75/50	Teleskop NW90/63
Art.no.	2675	3740	4626	10254
Effective length* (m)	1,50 - 5,55	1,50 - 5,55	2,00 - 11,70	2,00 - 11,70
Ventilation	●	●	●	●
Hose connection	NW50 (2")	NW63(2½")	NW50 (2")	NW63(2½")
ø Inner pipe (mm)	50 x 1,5mm	63 x 1,5mm	50 x 1,5mm	63 x 1,5mm
ø Outer pipe D _A (mm)	75 (3")	90 (3½")	75 (3")	90 (3½")
Req. drill hole D _B (mm)	≥85	≥100	≥85	≥100
Material	outer pipe PE / inner pipe aluminium (stainless steel on request)			
Weight	approx. 2kg/m	approx. 2kg/m	approx. 2kg/m	approx. 2kg/m

Accessories	Description	Art.no.
VS28 Complete set	115l	2886
	250l	5017
VS33 Complete set	115l	5939
	250l	5940
Hole saw	ø 85,5mm	4977
	ø 102mm	7537
Reducing connector	NW 75>50	1262
	NW 90>75	1971

Further accessories, see category „Blowing accessories“.

* freely selectable ● yes passive/active

Injection bezel

The injection bezel **art.no. 2911** facilitates the blowing injection of loose insulation materials in wall and ceiling structures. Also form-works with supporting battens with vapour barriers and air tightness membranes can be injected more secure.

Application: Insert the injection bezel behind the battens. Make a cross cut in the middle of the injection bezel with a (cutter) knife. The flexible, tear-resistant membrane \varnothing 30mm / 45mm (standard) / 68mm encloses blow-in hoses NW50-NW90 almost dust-tight. For seamless work, the use of two or more injection bezels is recommended.

The advantages/features at a glance

- ▶ Dimensions approx. 540x200x50mm (LxWxH), weight approx. 0,8kg
- ▶ Application allows quick change of blowing position
- ▶ Adjustable locking bracket for lath thicknesses of 20-44mm (when the stop rail is reversed, the result is 5-28mm) prevents the geomembranes from being pressed in and damaged

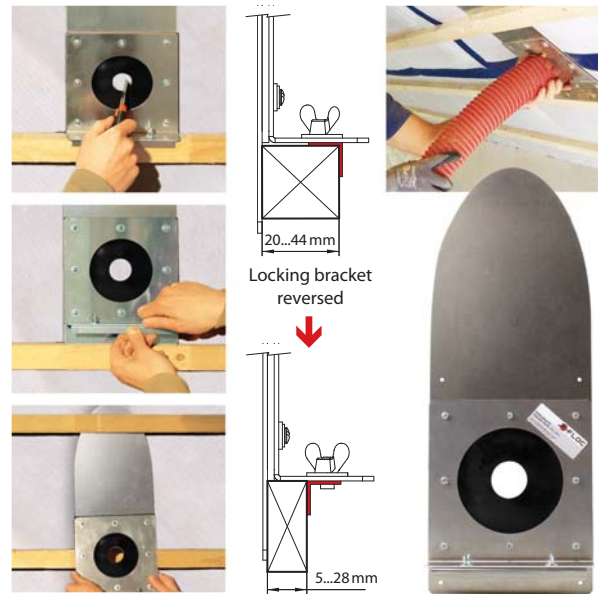

Detachable tubing port

The handy tubing port **art.no. 6737** (planking thicknesses 10-35mm) and **art.no. 7006** (planking thicknesses 30-80mm) is fastening in the drill hole by means of clamping mechanism.

The dimensions are 250x250mm (LxW). Thanks to the flexible seal and the multi-layer rubber rosette at the hose entry, it is self-sealing with respect to the compartment.

The advantages/features at a glance

- ▶ Can be used up to a planking thickness of max. 80mm
- ▶ Required drill hole \varnothing = 106,5 to 120mm
- ▶ Can be used for hose sizes NW50 (2"), NW63 (2½"), NW75 (3") and NW90 (3½")
- ▶ 3-layer rubber rosette for sealing the hose grommet
- ▶ Flexible sealing to prevent dust from escaping from the injection opening
- ▶ Ergonomic locking latch for easy opening and locking as well as for one-hand operation



Injection bezel universal

The injection bezel **art.no. 9209** or **Art.-Nr. 9209** is suitable for almost all injection tools, e.g. injection/conveying hoses, injection needles, injection lances, injection and rotary nozzles.

It is fixed in the drill hole or long hole with the help of the clamping mechanism (clamping bracket with spring) and is self-sealing. This leaves the professional's hands free to guide the injection tool and operate the machine control.

An extremely tear-resistant rubber membrane reliably seals against both smooth surfaces (e.g. injection needles) and hoses (e.g. injection or conveying hose). Excess air that enters the compartment during injection can escape easily thanks to the air-permeable sealing sponge. The sponge also compensates for different planking thicknesses.



X-Floc Insertion, sealing and venting accessories

The advantages/features at a glance

- ▶ **Art.no. 9209** for planking thicknesses 12...25mm
- ▶ **Art.-Nr. 9657** for planking thicknesses 30...80mm incl. 2x sealing sponge art.no. 9077 (15mm) and 2x sealing sponge art.no. 9661 (25mm)
- ▶ Required drill hole or long hole \varnothing 95 bis 120mm
- ▶ Rubber membrane for sealing the injection bezel
 Art.no. 8903 Seal \varnothing = 45mm (standard)
 Art.no. 8904 Seal \varnothing = 68mm (optional)
 Art.no. 8842 Seal \varnothing = 30mm (optional)
 Please specify optional design when ordering.
- ▶ Dimensions of injection bezel:
 230 x 280mm or incl. bracket handles 354 x 280mm

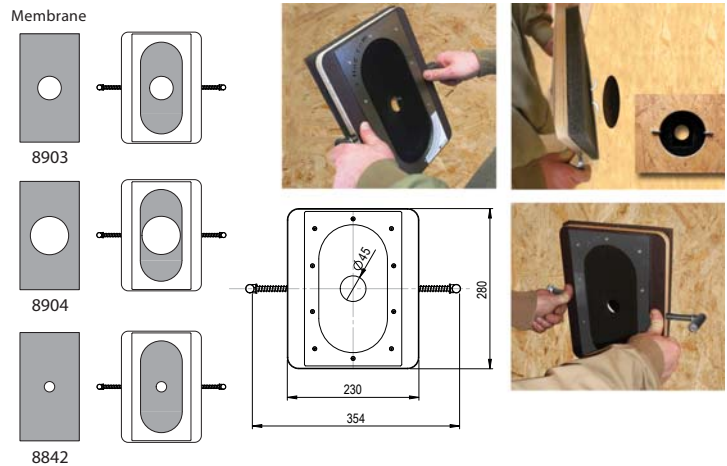

Clamping socket

The clamping socket **art.no. 2462** is used for dust-tight fastening of a NW75 (3") injection hose in all materials with a wall thickness of at least 10mm and a drill hole diameter between 106.5 and 108mm. The clamping socket is pressed into the injection opening, whereby the rubber seal provides additional hold and the prevention of dust emissions



Venting clamp connection

The ventilation clamping connector **art.no. 8422** with perforated vent cage is used for passive or active ventilation of components as well as for air guidance in the compartment. It is mainly used for airtight pressure-sensitive cladding.

The advantages/features at a glance

- ▶ Vent cage \varnothing approx. 75mm
- ▶ Total length approx. 85mm (or approx. 184,5mm)
- ▶ Clamping socket suitable for drill hole 106,5-108mm
- ▶ Hose connection / venting spigot NW75 (3")

Further application (drawing on the right): Drill a second hole at the lower end of the field, place the venting clamp socket **art.no. 5169** and now blow in as usual. The conveying air is discharged from the field, thus directing the material flow and minimising the pressure increase.



Sealing sponges

Sealing sponges are mainly used to seal injection openings during hose blowing.

Injection hose	Size (LxWxH)	Drill hole	Art.no.
NW38/50 (1½"/2")	250x250x40mm	35mm	7101
NW50/63 (2"/2½")	250x250x40mm	50mm	7100
NW63/75 (2½"/3")	250x250x40mm	70mm	7099
NW38/50 (1½"/2")	400x300x40mm	35mm	6336
NW50/63 (2"/2½")	400x300x40mm	50mm	3947
NW63/75 (2½"/3")	400x300x40mm	70mm	0292



X-Floc Blowing accessories

Hole saw HF with ejection

The hole saw HF was specially developed for drilling soft wood fibre boards (insulation boards, plaster base boards). Due to the special cutting geometry and the extremely thin cutting edge without a centring hole, very short drilling times as well as a distinctly clean drilling result can be achieved.

All HF hole saws have an ejector mechanism that makes it easy to remove the drill core. The dimensionally accurate drill core can be reused with glue to seal the hole.

In addition to the hole saw, the scope of delivery includes a plastic threaded box to protect the cutting edge as well as a sharpening stone, which is used for easy resharping of the hole saw according to the enclosed operating instructions.



Hole saw HF for exact blow-in openings in softwood fibreboards

Art.no.	9145	9334	9335
ø Drill hole	106,5mm	120mm	85mm
Cutting depth	approx. 85mm	approx. 85mm	approx. 85mm
Weight	approx. 0,6kg	approx. 0,6kg	approx. 0,6kg

Recommended speed for all hole saws HF approx. 400-600 U/min.

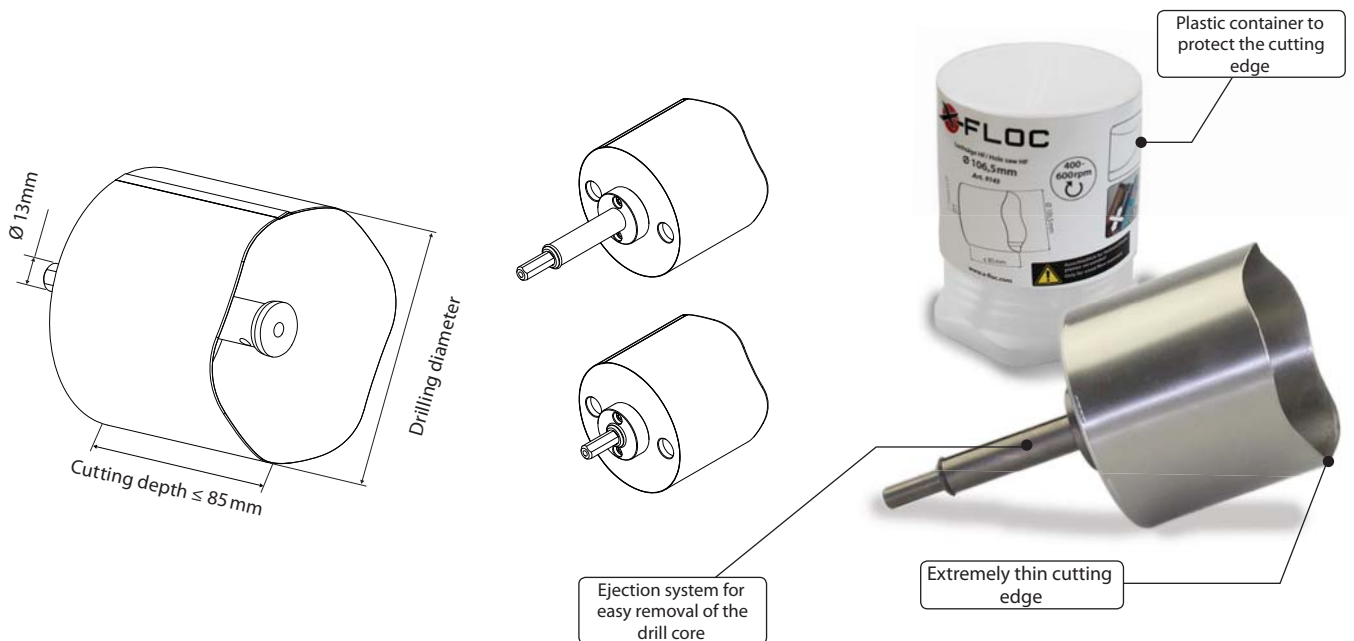

Application principle

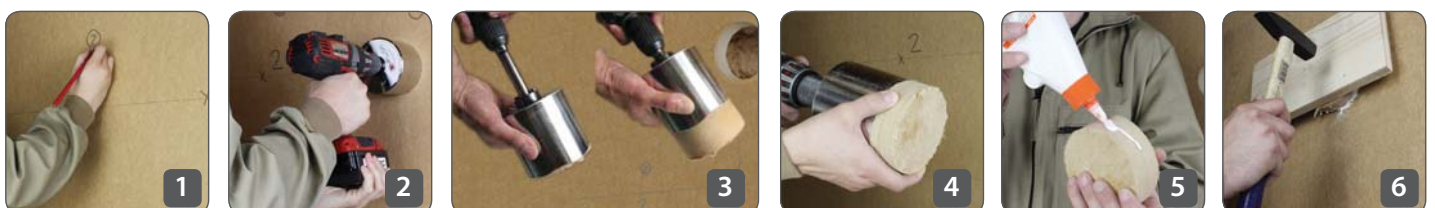

Mark the drill hole (1) Position the hole saw on the marking, switch on the machine and drill with moderate pressure (2) Pull the hole saw with drill core out of the planking and push out the drill core using the ejection system (3) Remove the drill core (4) Apply wood glue to the drill core (5) Insert the drill core flat according to the markings and fix it with a wooden board and hammer (6)

X-Floc Blowing accessories

Hole saw with ejection

This powerful hole saw is ideally suited for professional production of injection openings in a wide range of materials, such as wood, softwood fibreboard, chipboard, coated wood board, hardboard, PVC, glass fibre material, plasterboard, aerated concrete, clay bricks, Yton bricks and many more.

The carbide-tipped cylinder saw is characterised by short drilling times. Its excellent tooth geometry enables high cutting speeds as well as optimum chip removal even at maximum depth and prevents clogging or burning of the carbide teeth.

With the help of the easy-to-use ejection mechanism, the drill core can be removed in seconds and without the use of additional tools.

The HSS drill bits (art.no. 5032) in all sizes as well as SDS adapters (art. no. 6492) for the hole saw with ejection system are also available as optional accessories or spare parts.



Hole saw with ejection system for injection openings in a variety of materials

Art.no.	10025	4966	5149	5282	4977	5038	8836
ø Drill hole	105mm	106,5mm	108mm	120mm	85,5mm	65mm	52mm
Cutting depth	approx. 58mm	approx. 58mm	approx. 58mm	approx. 58mm	approx. 58mm	approx. 58mm	approx. 58mm
Weight	approx. 0,7kg	approx. 0,7kg	approx. ??? kg	approx. 0,8kg	approx. 0,7kg	approx. 0,5kg	approx. 0,6kg

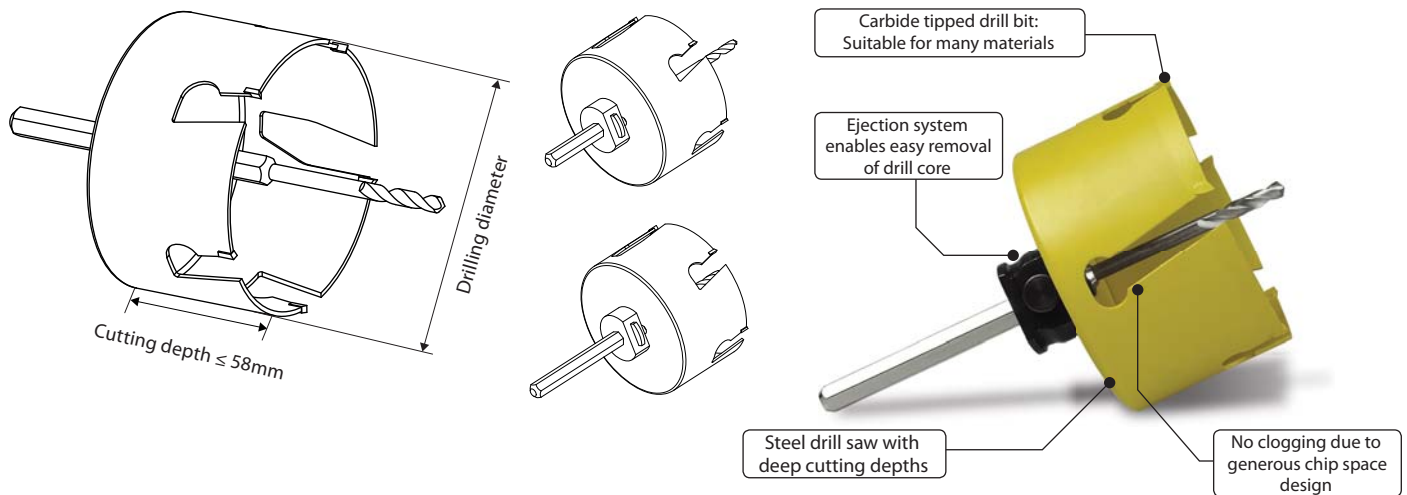

Application principle



Position the hole saw on the marking, switch on the machine and drill with moderate pressure (1) Pull the hole saw with drill core out of the planking (2) Remove the drill core (3) Blow in (4) Close the drill hole (5)

With the sealing corks and plugs (see next page) from our range, the injection openings can be perfectly closed.

In addition to the ones listed here, the X-Floc range also includes other hole saws. Please contact us for more information.

Sealing corks for injection openings

With the help of conical corks, drill holes can be sealed effortlessly and time-savingly in just a few steps. The cork is simply applied and pressed in until the injection opening is sealed flush. Thanks to the conical inlet, no gluing is necessary and the closure can be plastered over directly.

The corks are best used with hard planking materials such as OSB, hardboard or plasterboard. In combination with suitable materials and the appropriate drill hole, the injection opening can be sealed airtight and splash-proof.

Also ideal for permanently visible wood-based panels, such as cladding for buffer storage tanks, which have been blown in.

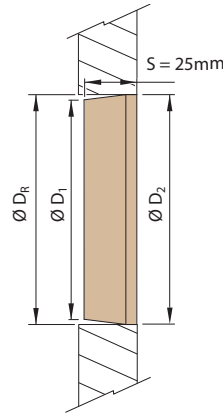

Art.no.	3626	3838	8837	2018	5818	2208	1948	4671
ø Drill hole D_R	26 - 32mm	35 - 39mm	52 - 54mm	64 - 67mm	78 - 83mm	84 - 87mm	105 - 108mm	120 - 122,5mm
ø D_1	26mm	35mm	51mm	64mm	78mm	84mm	105mm	120mm
ø D_2	33mm	40mm	55mm	68mm	84mm	88mm	109mm	123,5mm

Sealing plug made of wood fibre

These plugs are used when drill holes in soft wood fibre boards are to be sealed. The conical tooth profile facilitates their insertion and ensures a permanently secure hold. Small drilling tolerances are compensated for by the conical shape.

The plug is made of homogeneous, continuously hydrophobised wood fibre and ensures immediate weather protection. It also ensures a clean appearance and facilitates further processing, as it can be plastered over directly.

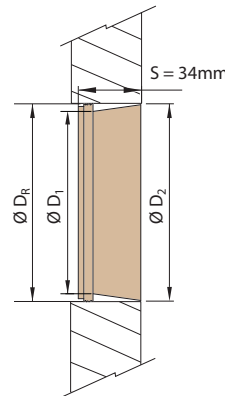

Art.no.	8950	8951
ø Drill hole D_R	104 - 108mm	120 - 122mm
ø D_1	102mm	112mm
ø D_2	109mm	120mm

X-Floc Dämmtechnik-Maschinen GmbH

Rosine-Starz-Straße 12 · 71272 Renningen · Germany

Telefon: +49-7159-80470-30 · Fax: -40

E-Mail: info@x-floc.com · www.x-floc.com

Your X-Floc Representative

